

PIM/Built-in converter with thyristor and brake (S series) 1200V / 25A / PIM

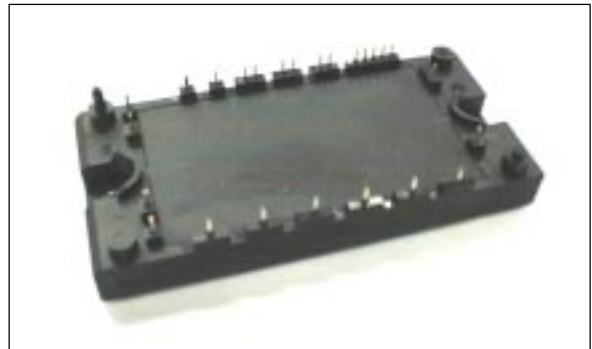

■ Features

- Low $V_{CE(sat)}$
- Compact Package
- P.C. Board Mount Module
- Converter Diode Bridge Dynamic Brake Circuit

■ Applications

- Inverter for Motor Drive
- AC and DC Servo Drive Amplifier
- Uninterruptible Power Supply

■ Maximum ratings and characteristics

● Absolute maximum ratings ($T_c=25^\circ\text{C}$ unless without specified)

Item	Symbol	Condition	Rating	Unit	
Inverter	Collector-Emitter voltage	V_{CES}	1200	V	
	Gate-Emitter voltage	V_{GES}	± 20	V	
	Collector current	I_c	Continuous	$T_c=25^\circ\text{C}$ 35	A
				$T_c=80^\circ\text{C}$ 25	
		I_{CP}	1ms	$T_c=25^\circ\text{C}$ 70	A
				$T_c=80^\circ\text{C}$ 50	
	$-I_c$		25	A	
Collector power dissipation	P_c	1 device	180	W	
Brake	Collector-Emitter voltage	V_{CES}	1200	V	
	Gate-Emitter voltage	V_{GES}	± 20	V	
	Collector current	I_c	Continuous	$T_c=25^\circ\text{C}$ 25	A
				$T_c=80^\circ\text{C}$ 15	
		I_{CP}	1ms	$T_c=25^\circ\text{C}$ 50	A
				$T_c=80^\circ\text{C}$ 30	
Collector power dissipation	P_c	1 device	110	W	
Thyristor	Repetitive peak reverse voltage(Diode)	V_{RRM}	1200	V	
	Repetitive peak off-state voltage	V_{DRM}	1600	V	
	Repetitive peak reverse voltage	V_{RRM}	1600	V	
	Average on-state current	$I_{T(AV)}$	50Hz/60Hz sine wave	25	A
	Surge On-state current (Non-Repetitive)	I_{TSM}	$T_j=125^\circ\text{C}$, 10ms half sine wave	290	A
	Junction temperature	T_{jw}		125	$^\circ\text{C}$
Converter	Repetitive peak reverse voltage	V_{RRM}	1600	V	
	Average output current	I_b	50Hz/60Hz sine wave	25	A
	Surge current (Non-Repetitive)	I_{FSM}	$T_j=150^\circ\text{C}$, 10ms	260	A
	I^2t (Non-Repetitive)	I^2t	half sine wave	338	A^2s
Junction temperature (except Thyristor)	T_j		+150	$^\circ\text{C}$	
Storage temperature	T_{stg}		-40 to +125	$^\circ\text{C}$	
Isolation between terminal and copper base *2 voltage between thermistor and others *3	V_{iso}	AC : 1 minute	AC 2500	V	
			AC 2500	V	
Mounting screw torque			1.7 *1	N·m	

*1 Recommendable value : 1.3 to 1.7 N·m (M4)

*2 All terminals should be connected together when isolation test will be done.

*3 Terminal 8 and 9 should be connected together. Terminal 1 to 7 and 10 to 26 should be connected together and shorted to copper base.

● Electrical characteristics (Tj=25°C unless otherwise specified)

Item	Symbol	Condition	Characteristics			Unit		
			Min.	Typ.	Max.			
Inverter	Zero gate voltage collector current	ICES	VCE=1200V, VGE=0V		100	μA		
	Gate-Emitter leakage current	IGES	VCE=0V, VGE=±20V		200	nA		
	Gate-Emitter threshold voltage	VGE(th)	VCE=20V, IC=25mA		5.5	7.2	8.5	V
	Collector-Emitter saturation voltage	VCE(sat)	VGE=15V, IC=25A	chip	2.1		V	
				terminal	2.2	2.6		
	Input capacitance	Cies	VGE=0V, VCE=10V, f=1MHz		3000		pF	
	Turn-on time	ton	VCC=600V		0.35	1.2	μs	
		tr	IC=25A		0.25	0.6		
	Turn-off	toff	VGE=±15V		0.45	1.0		
		tf	RG=51Ω		0.08	0.3		
Forward on voltage	VF	IF=25A	chip	2.3		V		
			terminal	2.4	3.2			
Reverse recovery time of FRD	trr	IF=25A			350	ns		
Brake	Zero gate voltage collector current	ICES	VCEs=1200V, VGE=0V		100	μA		
	Gate-Emitter leakage current	IGES	VCE=0V, VGE=±20V		200	nA		
	Collector-Emitter saturation voltage	VCE(sat)	IC=15A, VGE=15V	chip	2.1		V	
				terminal	2.2	2.6		
	Turn-on time	ton	VCC=600V		0.35	1.2	μs	
		tr	IC=15A		0.25	0.6		
	Turn-off time	toff	VGE=±15V		0.45	1.0		
		tf	RG=82Ω		0.08	0.3		
	Reverse current	Irrm	VR=1200V			100	μA	
	off-state current	IDM	VDM=1600V			1.0	mA	
Thyristor	Reverse current	Irrm	VRM=1600V			1.0	mA	
	Gate trigger current	IGT	VD=6V, IT=1A			100	mA	
	Gate trigger voltage	VGT	VD=6V, IT=1A			2.5	V	
	On-state voltage	VTM	ITM=25A	chip	1.05	1.15	V	
				terminal	1.1			
Converter	Forward on voltage	VFM	IF=25A	chip	1.1	V		
		terminal		1.2	1.5			
	Reverse current	Irrm	VR=1600V			100	μA	
Thyristor	Resistance	R	T=25°C		5000	Ω		
			T=100°C		465		495	520
	B value	B	T=25/50°C		3305	3375	3450	K

● Thermal resistance Characteristics

Item	Symbol	Condition	Characteristics			Unit
			Min.	Typ.	Max.	
Thermal resistance (1 device)	Rth(j-c)	Inverter IGBT			0.69	°C/W
		Inverter FWD			1.30	
		Brake IGBT			1.14	
		Thyristor			1.00	
		Converter Diode			0.90	
Contact thermal resistance *	Rth(c-f)	With thermal compound		0.05		

* This is the value which is defined mounting on the additional cooling fin with thermal compound

■ Characteristics (Representative)

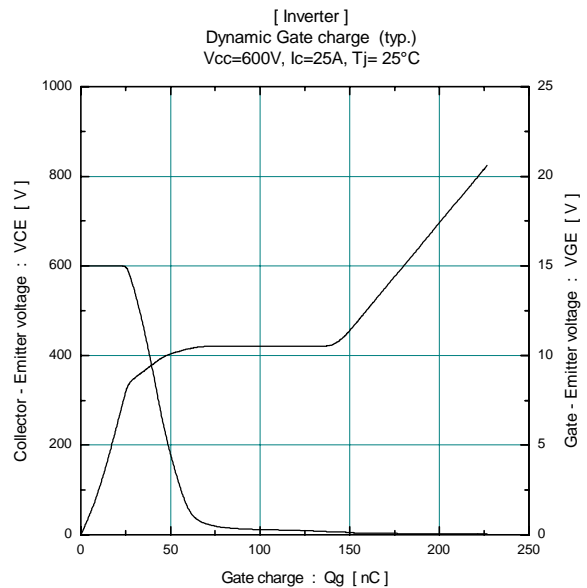
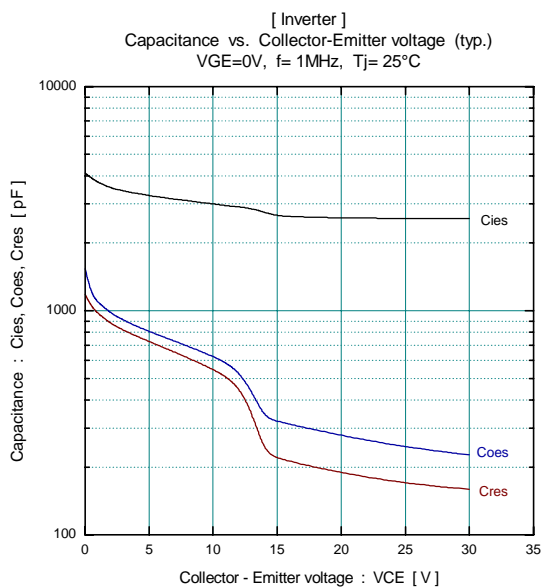
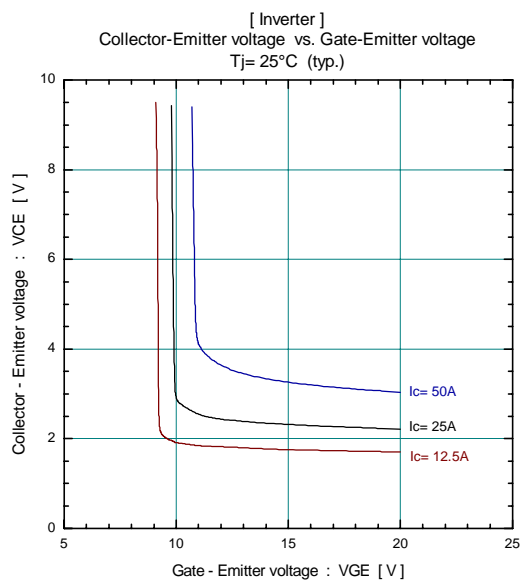
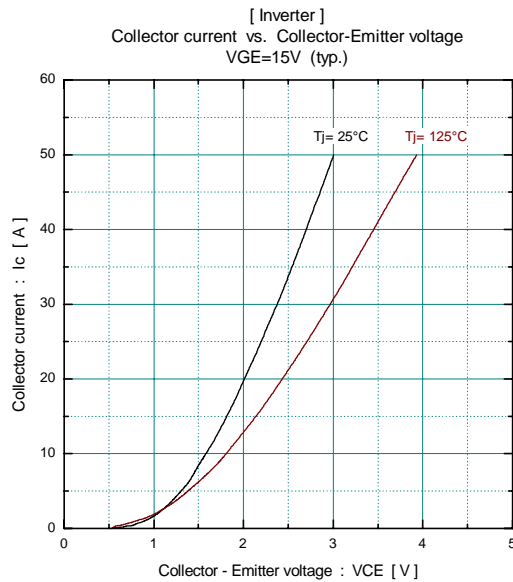
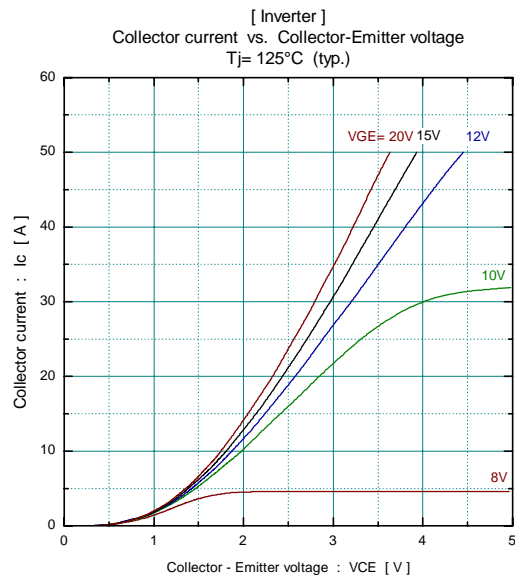
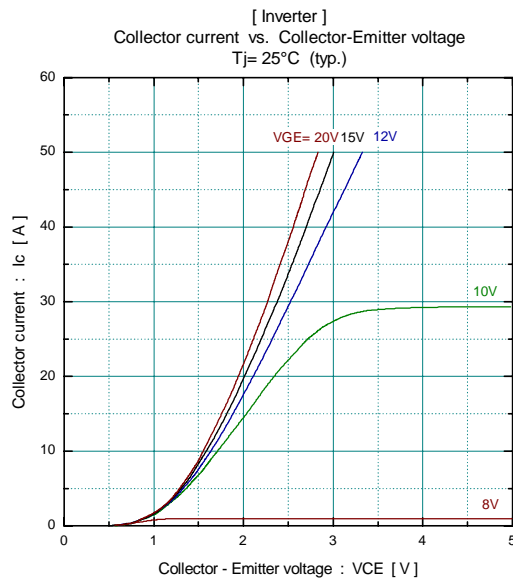

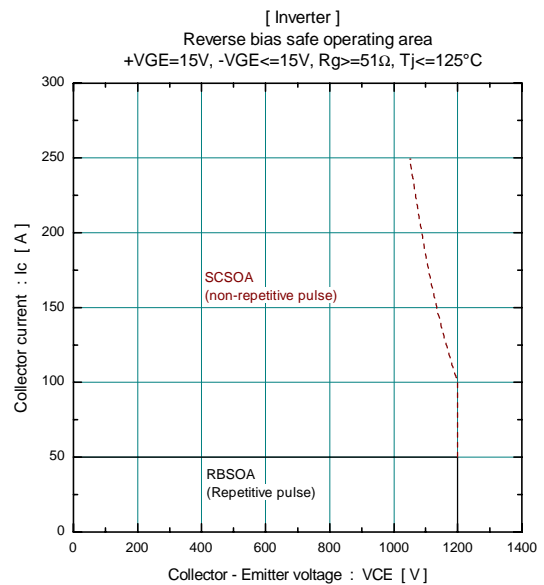
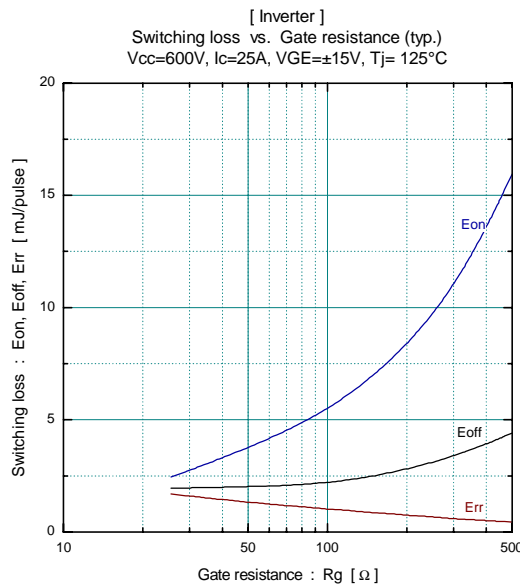
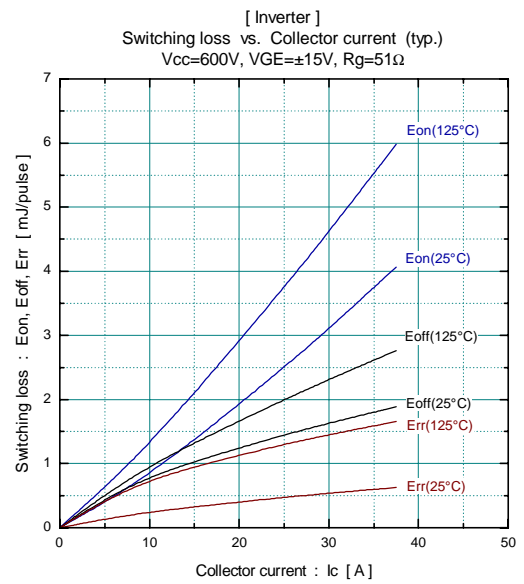
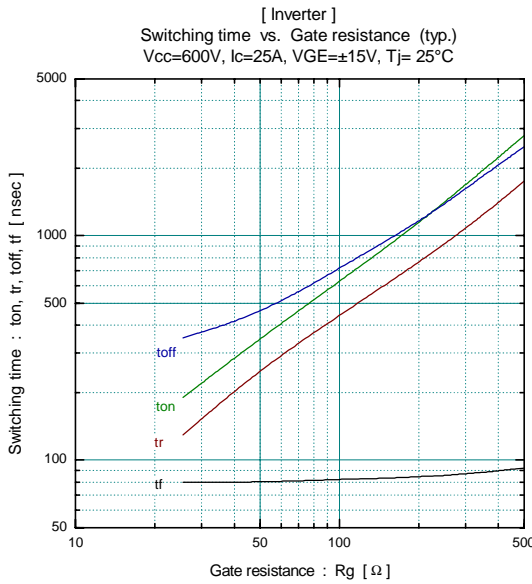
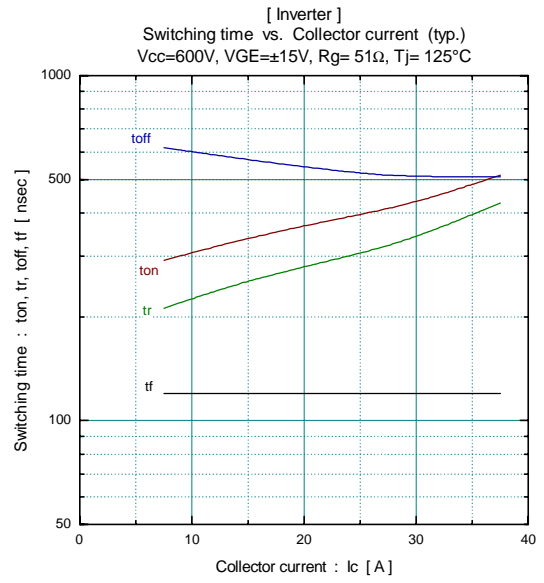
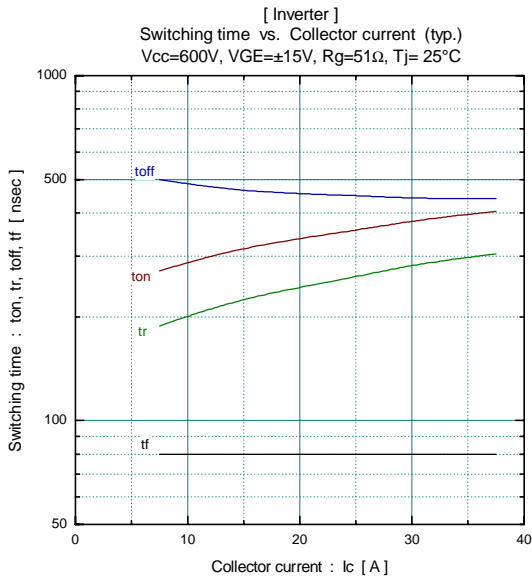

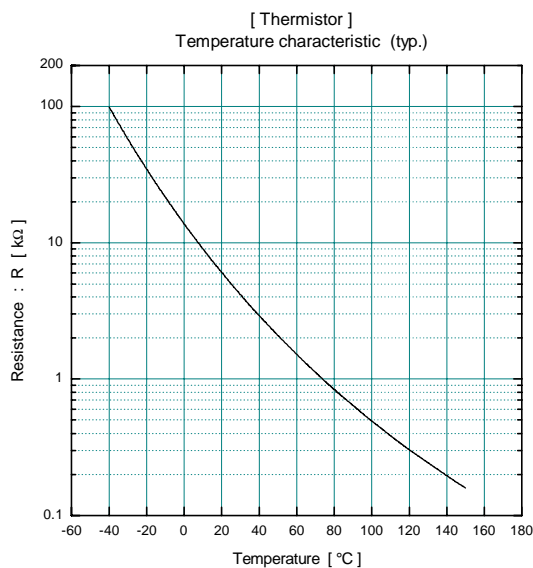
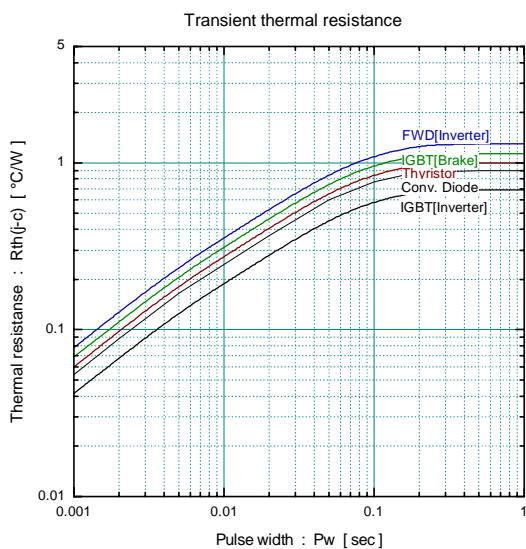
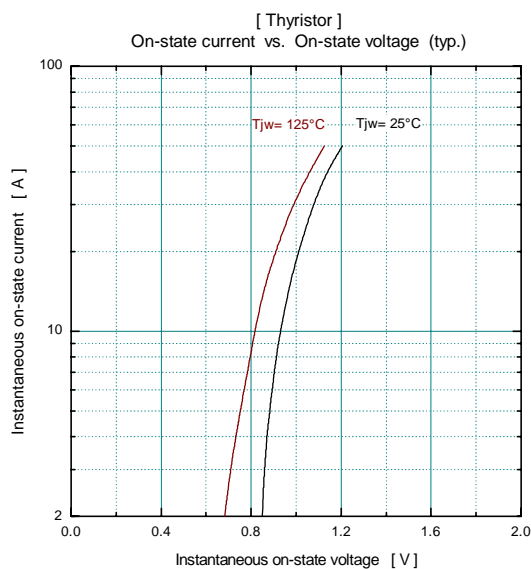
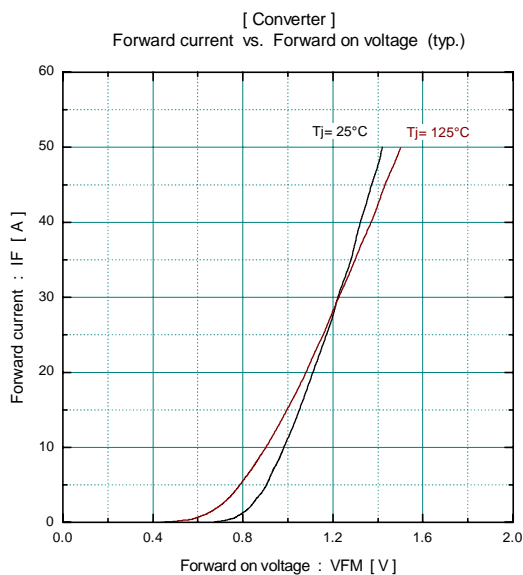
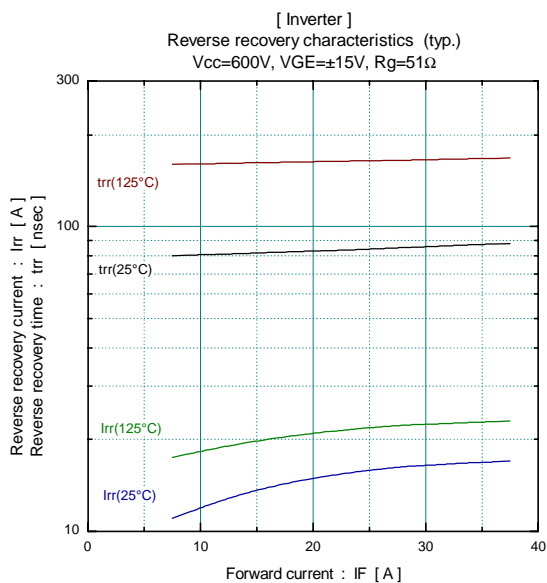
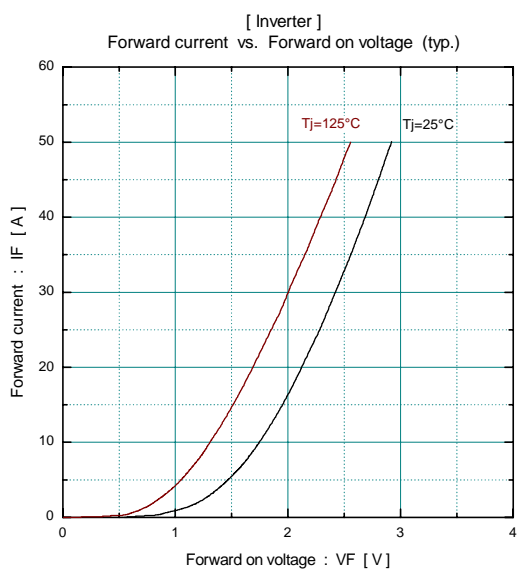

[Brake]
Collector current vs. Collector-Emittor voltage
 $T_j = 25^\circ\text{C}$ (typ.)

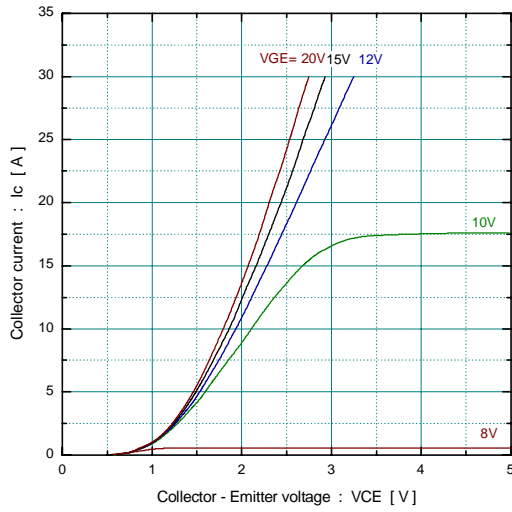

[Brake]
Collector current vs. Collector-Emittor voltage
 $T_j = 125^\circ\text{C}$ (typ.)

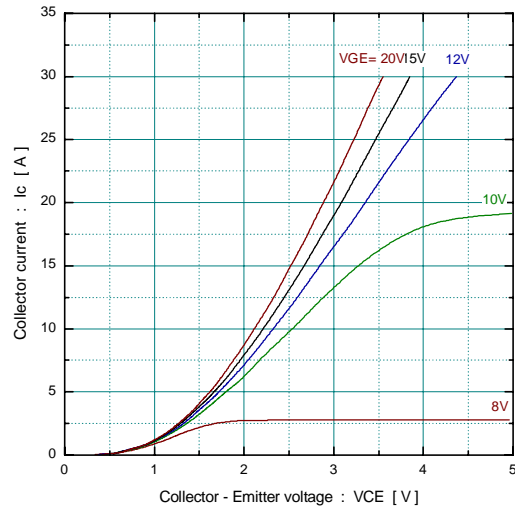

[Brake]
Collector current vs. Collector-Emittor voltage
 $V_{GE} = 15\text{V}$ (typ.)

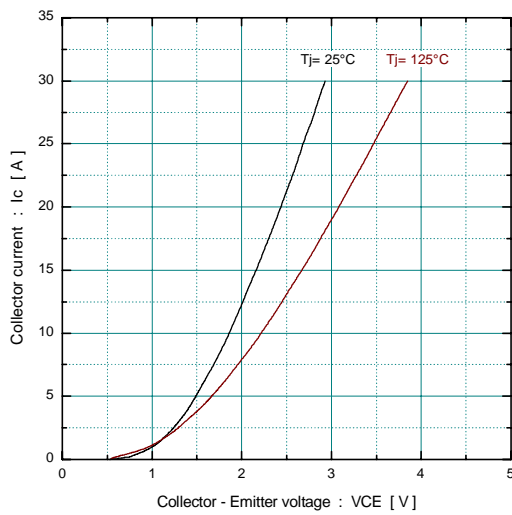

[Brake]
Collector-Emittor voltage vs. Gate-Emittor voltage
 $T_j = 25^\circ\text{C}$ (typ.)

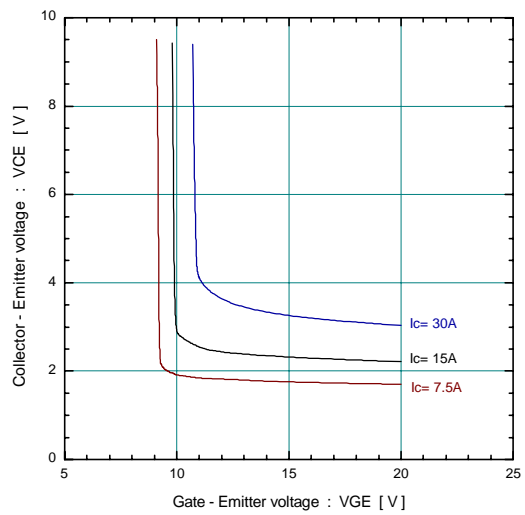

[Brake]
Capacitance vs. Collector-Emittor voltage (typ.)
 $V_{GE} = 0\text{V}$, $f = 1\text{MHz}$, $T_j = 25^\circ\text{C}$

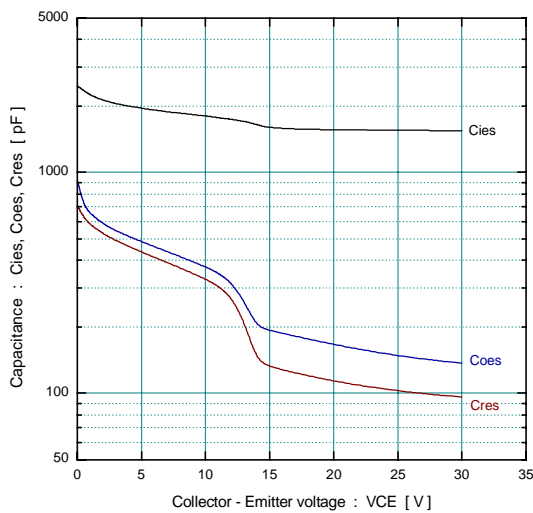

[Brake]
Dynamic Gate charge (typ.)
 $V_{CC} = 600\text{V}$, $I_c = 15\text{A}$, $T_j = 25^\circ\text{C}$

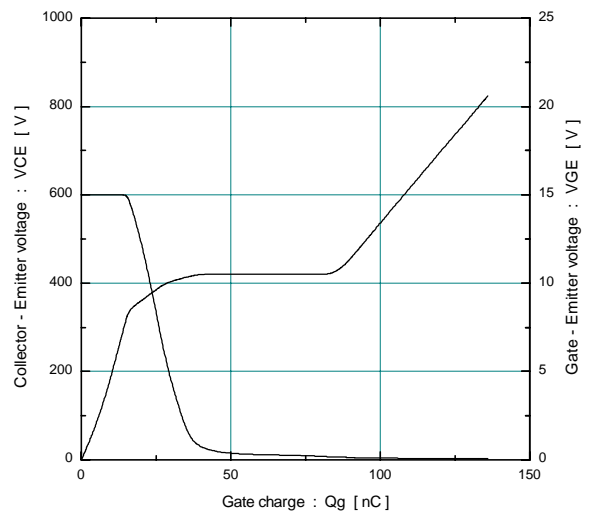

Outline Drawings, mm

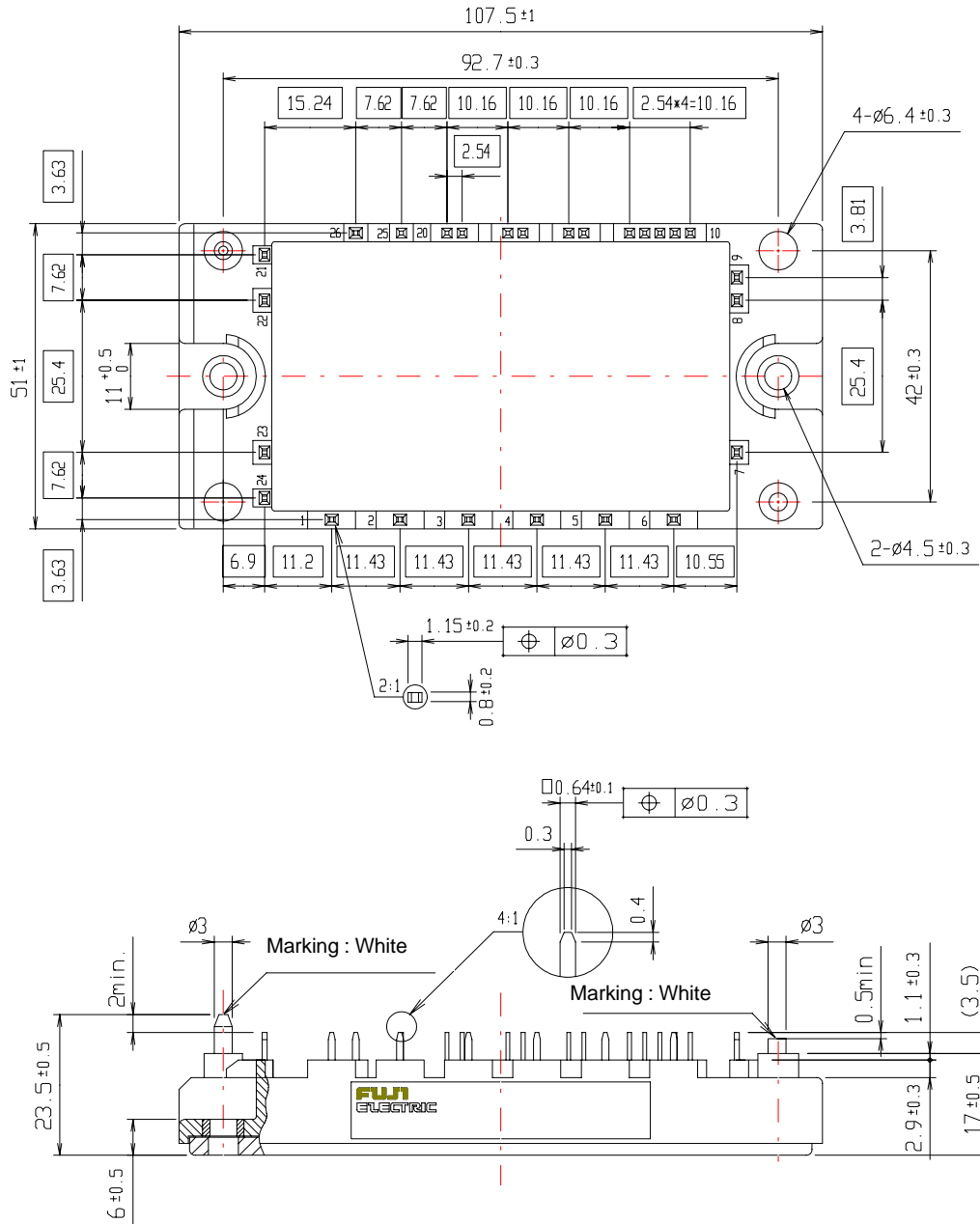

Equivalent Circuit Schematic

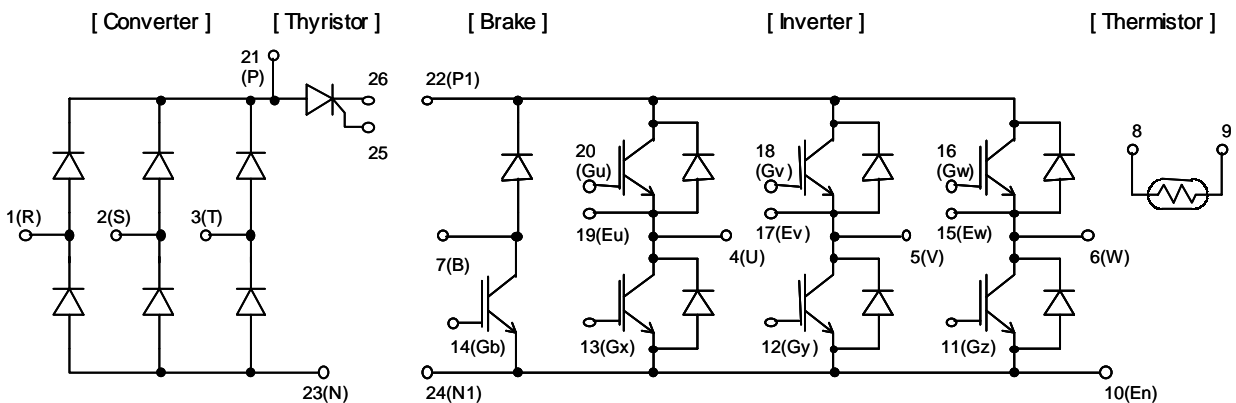

This datasheet has been downloaded from:

www.DatasheetCatalog.com

Datasheets for electronic components.