

Three Phase Bridge + Thyristor

VRRM / VDRM 800 to 1800V
IFAV / ITAV 200Amp

Features

- Blocking voltage:800 to 1800V
- Three Phase Bridge and a Thyristor
- Low Forward Voltage

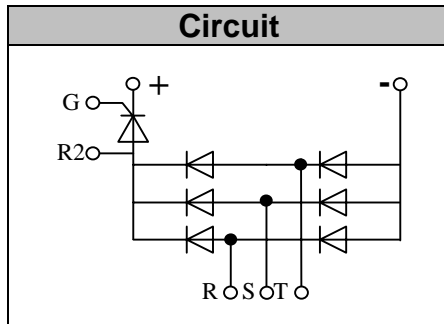

Applications

- Inverter for AC or DC motor control
- Current stabilized power supply
- Switching power supply
- UL recognized applied for file no. E360040

Module Type

TYPE	VRRM / VDRM	V _{RSM}
MT200DT08L2	800V	900V
MT200DT12L2	1200V	1300V
MT200DT16L2	1600V	1700V
MT200DT18T2	1800V	1900V

◆ Diode

Maximum Ratings

Symbol	Item	Conditions	Values	Units
I _D	Output Current(D.C.)	T _c =96°C Three phase full wave	200	A
I _{FSM}	Surge forward current	t=10ms T _{vj} =45°C	1900	A
i ² t	Circuit Fusing Consideration		18050	A ² s
Visol	Isolation Breakdown Voltage(R.M.S)	a.c.50HZ;r.m.s.;1min	3000	V
T _{vj}	Operating Junction Temperature		-40 to +150	°C
T _{stg}	Storage Temperature		-40 to +125	°C
M _t	Mounting Torque	To terminals(M4)	2±15%	Nm
M _t		To terminals(M6)	5±15%	Nm
M _s		To heatsink(M6)	5±15%	Nm
Weight		Module (Approximately)	320	g

Thermal Characteristics

Symbol	Item	Conditions	Values	Units
R _{th(j-c)}	Thermal Impedance, max.	Junction to Case(TOTAL)	0.12	°C/W
R _{th(c-s)}	Thermal Impedance, max.	Case to Heat sink	0.06	°C/W

Electrical Characteristics

Symbol	Item	Conditions	Values	Units
V _{FM}	Forward Voltage Drop, max.	T=25°C I _F =200A	1.35	V
I _{RRM}	Repetitive Peak Reverse Current, max.	T _{vj} =25°C V _{RD} =V _{RRM} T _{vj} =150°C V _{RD} =V _{RRM}	≤2 ≤10	mA mA

◆ Thyristor Maximum Ratings

Symbol	Item	Conditions	Values	Units
I_{TAV}	Average On-State Current	$T_c=93^{\circ}\text{C}$, Single Phase half wave 180° conduction	200	A
I_{TSM}	Surge On-State Current	$T_{VJ}=45^{\circ}\text{C}$ $t=10\text{ms}$ (50Hz), sine $VR=0$	1900	A
i^2t	Circuit Fusing Consideration		18050	A^2s
V_{isol}	Isolation Breakdown Voltage(R.M.S)	a.c.50HZ;r.m.s.;1 min	3000	V
T_{vj}	Operating Junction Temperature		-40 to +125	$^{\circ}\text{C}$
T_{stg}	Storage Temperature		-40 to +125	$^{\circ}\text{C}$
M_t	Mounting Torque	To terminals(M4)	$2\pm 15\%$	Nm
M_t		To terminals(M6)	$5\pm 15\%$	
M_s		To heatsink(M6)	$5\pm 15\%$	Nm
di/dt	Critical Rate of Rise of On-State Current	$T_{VJ}=T_{VJM}$, $V_D=1/2V_{DRM}$, $I_G=100\text{mA}$ $dI_G/dt=0.1\text{A}/\mu\text{s}$	200	$\text{A}/\mu\text{s}$
dv/dt	Critical Rate of Rise of Off-State Voltage, min.	$T_J=T_{VJM}$, $V_D=2/3V_{DRM}$, linear voltage rise	500	$\text{V}/\mu\text{s}$

Electrical and Thermal Characteristics

Symbol	Item	Conditions	Values			Units
			Min.	Typ.	Max.	
V_{TM}	Peak On-State Voltage, max.	$T=25^{\circ}\text{C}$ $I_T=200\text{A}$			1.40	V
I_{RRM}/I_{DRM}	Repetitive Peak Reverse Current, max. / Repetitive Peak Off-State Current, max.	$T_{VJ}=T_{VJM}$, $V_R=V_{RRM}$, $V_D=V_{DRM}$			100	mA
V_{GT}	Gate Trigger Voltage, max.	$T_{VJ}=25^{\circ}\text{C}$, $V_D=6\text{V}$			3	V
I_{GT}	Gate Trigger Current, max.	$T_{VJ}=25^{\circ}\text{C}$, $V_D=6\text{V}$			150	mA
$R_{th(j-c)}$	Thermal Impedance, max.	Junction to Case			0.14	$^{\circ}\text{C}/\text{W}$
$R_{th(c-s)}$	Thermal Impedance, max.	Case to Heatsink			0.06	$^{\circ}\text{C}/\text{W}$

Performance Curves

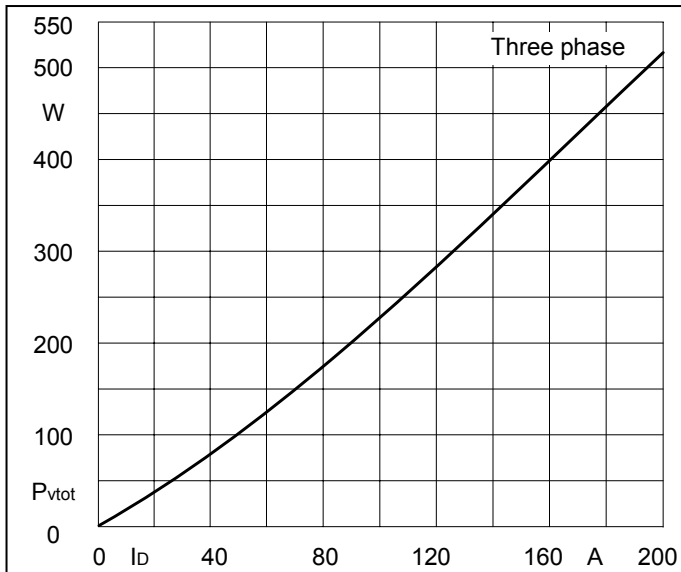

Fig1. Power dissipation

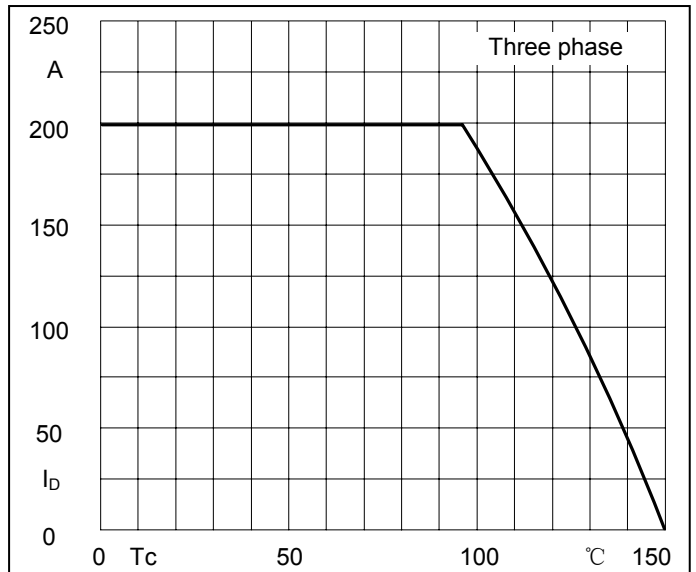

Fig2. Forward Current Derating Curve

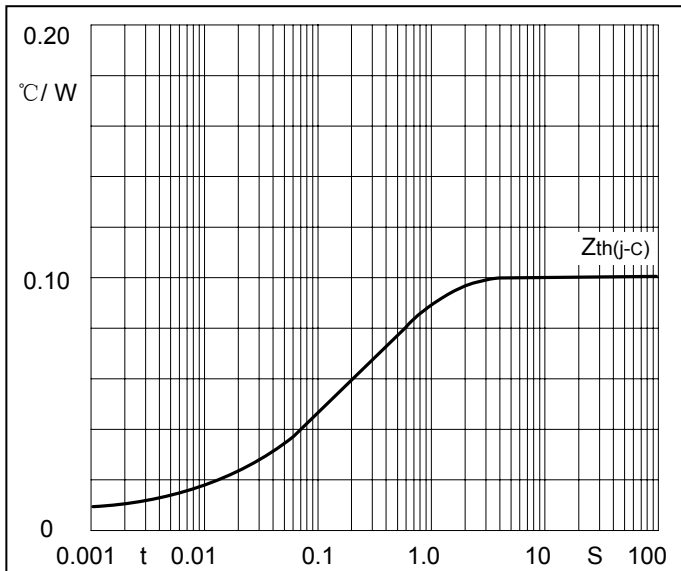

Fig3. Transient thermal impedance

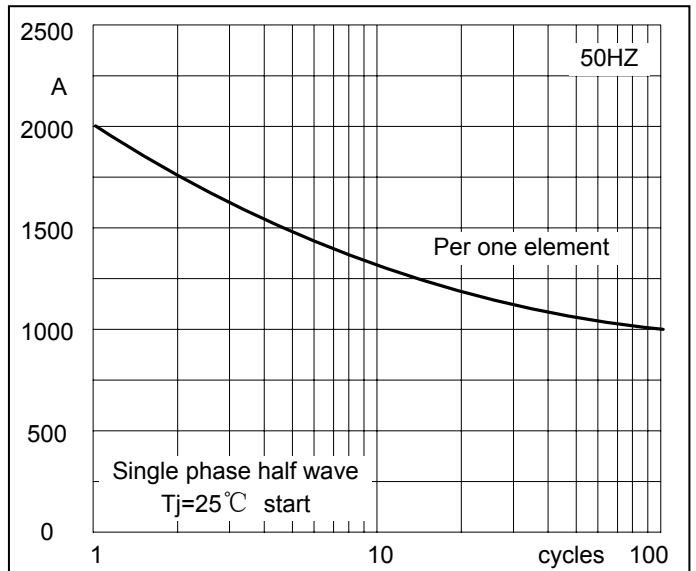

Fig4. Max Non-Repetitive Forward Surge Current

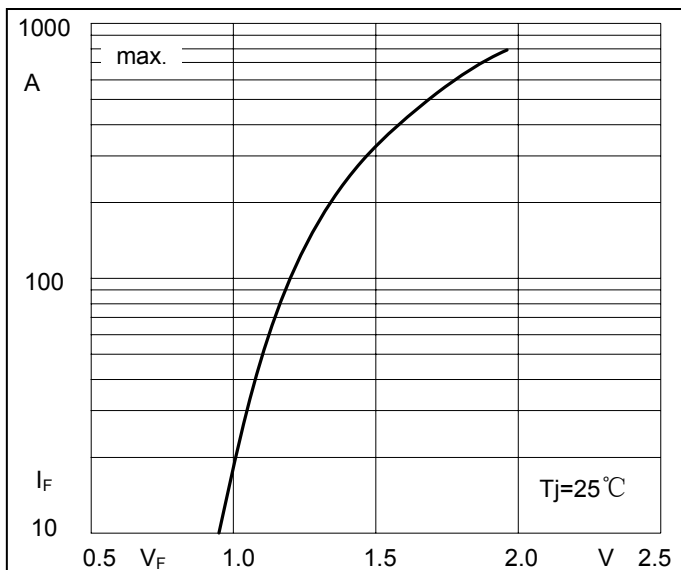

Fig5. Forward Characteristics

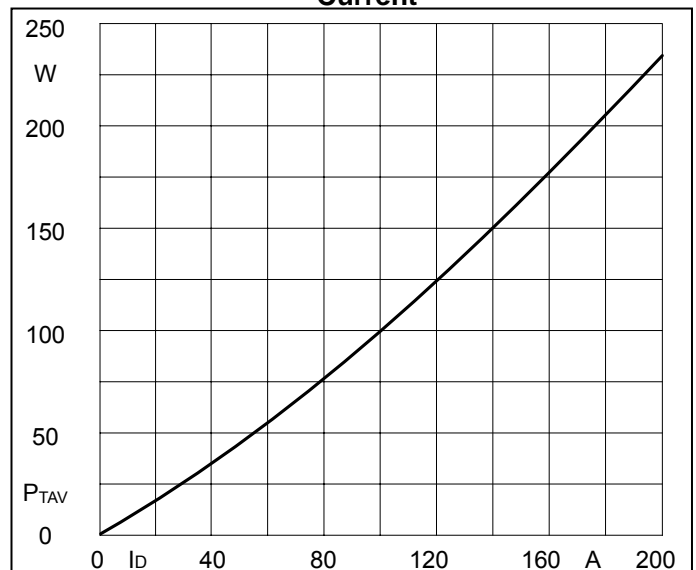

Fig6. SCR Power dissipation

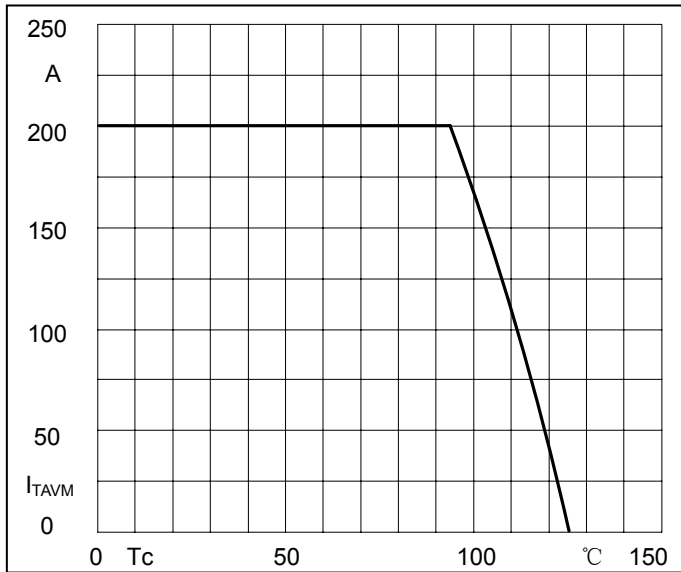

Fig7. SCR Forward Current Derating Curve

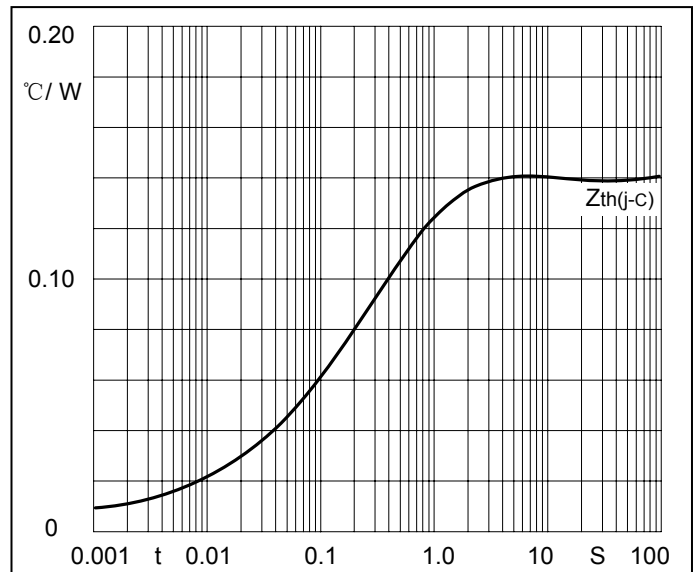

Fig8. SCR Transient thermal impedance

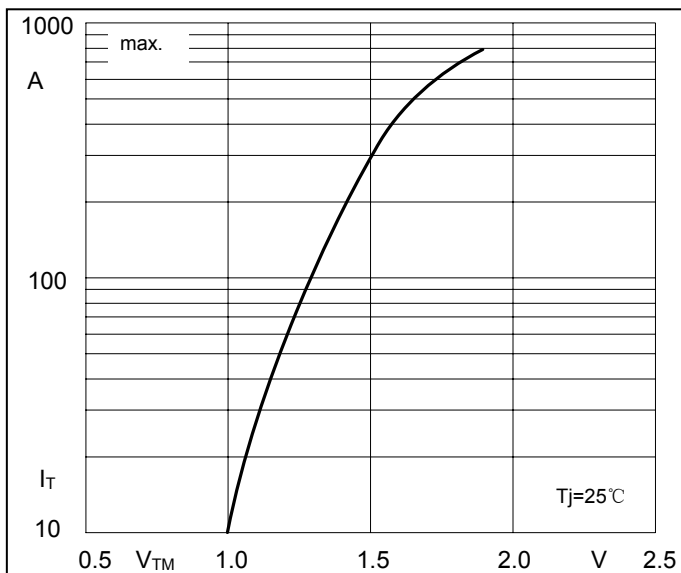

Fig9. SCR Forward Characteristics

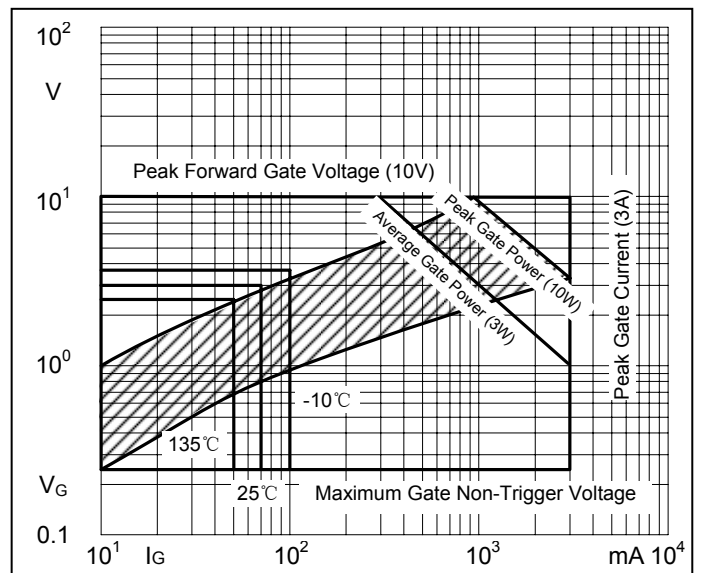

Fig10. Gate trigger Characteristics

Package Outline Information

